



FD Trinitron
WEGA[®]

Operating Instructions

KV-27FS100L

WARNING

To reduce the risk of fire or electric shock, do not expose the TV to rain or moisture.



This symbol is intended to alert the user to the presence of uninsulated "dangerous voltage" within the product's enclosure that may be of sufficient magnitude to constitute a risk of electric shock to persons.



This symbol is intended to alert the user to the presence of important operating and maintenance (servicing) instructions in the literature accompanying the appliance.

Note to the CATV Installer

This reminder is provided to call the CATV system installer's attention to Article 820-40 of the NEC that provides guidelines for proper grounding and, in particular, specifies that the cable ground shall be connected to the grounding system of the building as close to the point of cable entry as practical.

SAFETY PRECAUTIONS

- Operate the TV only on 120 V AC.
- One blade of the power plug is wider than the other for safety purposes and will fit into the power outlet only one way. If you are unable to insert the plug fully into the outlet, contact your dealer.
- If any liquid or solid object falls into the TV, unplug it and have it checked by qualified personnel before operating it further.

CAUTION

When using TV games, computers, and similar products with your TV, keep the brightness and contrast functions at low settings. If a fixed (non-moving) pattern is left on the screen for long periods of time at a high brightness or contrast setting, the image can be permanently imprinted onto the screen. Continuously watching the same channel can cause the imprint of station logos onto the TV screen. These types of imprints are not covered by your warranty because they are the results of misuse.



To reduce the risk of electric shock, do not use this polarized plug with an extension cord, receptacle, or other outlet unless the blades can be fully inserted to prevent blade exposure.



You are cautioned that any changes or modifications not expressly approved in this manual could void your authority to operate this equipment.

NOTIFICATION

This equipment has been tested and found to comply with the limits for a Class B digital device pursuant to Part 15 of the FCC Rules. These limits are designed to provide reasonable protection against harmful interference in a residential installation. This equipment generates, uses, and can radiate radio frequency energy and, if not installed and used in accordance with the instructions, may cause harmful interference with radio communications. However, there is no guarantee that interference will not occur in a particular installation. If this equipment does cause harmful interference to radio or television reception, which can be determined by turning the equipment off and on, the user is encouraged to try to correct the interference by one or more of the following measures:

- Reorient or relocate the receiving antennas.
- Increase the separation between the equipment and receiver.
- Connect the equipment into an outlet on a circuit different from that to which the receiver is connected.
- Consult the dealer or an experienced radio/TV technician for help.

Protecting the TV

- To prevent internal heat build-up, do not block the ventilation openings.
- Do not install the TV in a hot or humid place, or in a place subject to excessive dust or mechanical vibration.

Note on Caption Vision

This television receiver provides display of television closed captioning in accordance with § 15.119 of the FCC rules. Use of this television for other than private viewing of programs broadcast on UHF or VHF or transmitted by cable companies for the use of the general public may require authorization from the broadcaster-cable company and/or program owner.

Owner's Record

The model and serial numbers are located on the front cover of this manual and at the rear of your TV.

Trademarks and Copyrights

ENERGY STAR® is a registered mark.



As an ENERGY STAR® Partner, Sony has determined that this product or product model meets the ENERGY STAR® guidelines for energy efficiency.

WEGA®, FD Trinitron and Caption Vision are registered trademarks of Sony Corporation.

IMPORTANT SAFEGUARDS

For your protection, please read these instructions completely, and keep this manual for future reference. Carefully observe and comply with all warnings, cautions and instructions placed on the set, or described in the operating instructions or service manual.

WARNING

To guard against injury, the following basic safety precautions should be observed in the installation, use, and servicing of the set.

Use

Power Sources

This set should be operated only from the type of power source indicated on the serial/model plate. If you are not sure of the type of electrical power supplied to your home, consult your dealer or local power company. For those sets designed to operate from battery power, refer to the operating instructions.



Grounding or Polarization

This set may be equipped with a polarized alternating current plug (a plug having one blade wider than other). This plug will fit into the power outlet only one way. This is a safety feature. If you are unable to insert the plug fully into the outlet, try reversing the plug. If the plug still fails to fit, contact your electrician to replace your obsolete outlet. Do not defeat the safety purpose of the polarized plug.

For the set with a polarized AC power cord plug

This plug will fit into the power outlet only one way. This is a safety feature. If you are unable to insert the plug fully into the outlet, try reversing the plug. If the plug still fails to fit, contact your electrician to have a suitable outlet installed. Do not defeat the safety purpose of the polarized plug by forcing it in.

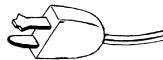

Alternate Warning

For the set with a three-wire grounding type AC plug

This plug will only fit into a grounding-type power outlet. This is a safety feature. If you are unable to insert the plug into the outlet, contact your electrician to have a suitable outlet installed. Do not defeat the safety purpose of the grounding plug.

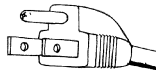

Overloading

Do not overload wall outlets, extension cords or convenience receptacles beyond their capacity, since this can result in fire or electric shock.

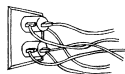

Always turn the set off when it is not to be used. When the set is left unattended and unused for long periods of time, unplug it from the wall outlet as a precaution against the possibility of an internal malfunction that could create a fire hazard.

Do not disconnect the antenna or the power cord during a heavy storm. Lightning may strike while you are holding the cable or cord, causing serious injury. Turn off your TV and wait for the weather to improve.

Object and Liquid Entry

Never push objects of any kind into the set through the cabinet slots as they may touch dangerous voltage points or short out parts that could result in a fire or electric shock. Never spill liquid of any kind on the set.



Attachments

Do not use attachments not recommended by the manufacturer, as they may cause hazards.

Do not place any objects, especially heavy objects, on top of the set. The object may fall from the set, causing injury.

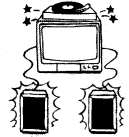

Cleaning

Unplug the set from the wall outlet before cleaning or polishing it. Do not use liquid cleaners or aerosol cleaners. Use a cloth lightly dampened with water for cleaning the exterior of the set.



If a snapping or popping sound from a TV set is continuous or frequent while the TV is operating, unplug the TV and consult your dealer or service technician. It is normal for some TV sets to make occasional snapping or popping sounds, particularly when being turned on or off.



Installation

Always use two or more people to lift or move the set. The set is heavy and the bottom surface is flat. Serious injury can result from trying to move the set by yourself alone, or from unsteady handling.

Install the set on a stable, level surface.

Water and Moisture

Do not use power-line operated sets near water — for example, near a bathtub, washbowl, kitchen sink, or laundry tub, in a wet basement, or near a swimming pool, etc.



Accessories

Do not place the set on an unstable cart, stand, tripod, bracket, table, or shelf. The set may fall, causing serious injury to a child or an adult, and serious damage to the set. Use



only a cart or stand recommended by the manufacturer for the specific model of TV. Any mounting of the product should follow the manufacturer's instructions, and should use a mounting accessory recommended by the manufacturer. An appliance and cart combination should be moved with care. Quick stops, excessive force, and uneven surfaces may cause the appliance and cart combination to overturn.

Ventilation

The slots and openings in the cabinet and in the back or bottom are provided for necessary ventilation. To ensure reliable operation of the set, and to protect it from overheating, these slots and openings must never be blocked or covered.

- Never cover the slots and openings with a cloth or other materials.



- Never block the slots and openings by placing the set on a bed, sofa, rug or other similar surface.

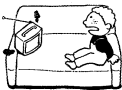

- Never place the set in a confined space, such as a bookcase or built-in cabinet, unless proper ventilation is provided.



- Do not place the set near or over a radiator or heat register, or where it is exposed to direct sunlight.



Power-Cord Protection

Do not allow anything to rest on or roll over the power cord, and do not place the set where the power cord is subject to wear or abuse.



Antennas

Outdoor Antenna Grounding

If an outdoor antenna is installed, follow the precautions below. An outdoor antenna system should not be located in the vicinity of overhead power lines or other electric light or power circuits, or where it can come in contact with such power lines or circuits.

WHEN INSTALLING AN OUTDOOR ANTENNA SYSTEM, EXTREME CARE SHOULD BE TAKEN TO KEEP FROM CONTACTING SUCH POWER LINES OR CIRCUITS AS CONTACT WITH THEM IS ALMOST INVARIABLY FATAL.

Be sure the antenna system is grounded so as to provide some protection against voltage surges and built-up static charges. Section 810 of the National Electrical Code (NEC) in USA and Section 54 of the Canadian Electrical Code in Canada provides information with respect to proper grounding of the mast and supporting structure, grounding of the lead-in wire to an antenna discharge unit, size of grounding conductors, location of antenna discharge unit, connection to grounding electrodes, and requirements for the grounding electrode.

Antenna Grounding According to the NEC

Antenna Grounding According to the National Electrical Code, ANSI/NFPA 70.

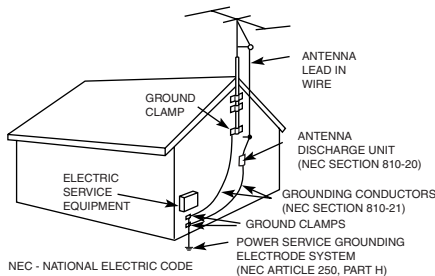

Lightning

For added protection for this television receiver during a lightning storm, or when it is left unattended and unused for long periods of time, unplug it from the wall outlet and disconnect the antenna. This will prevent damage to the receiver due to lightning and power-line surges.

Service

Damage Requiring Service

Unplug the set from the wall outlet and refer servicing to qualified service personnel under the following conditions:

- When the power cord or plug is damaged or frayed.



- If liquid has been spilled into the set or objects have fallen into the product.



- If the set has been exposed to rain or water.



- If the set has been subject to excessive shock by being dropped, or the cabinet has been damaged.



- If the set does not operate normally when following the operating instructions. Adjust only those controls that are specified in the operating instructions. Improper adjustment of other controls may result in damage and will often require extensive work by a qualified technician to restore the set to normal operation.



- When the set exhibits a distinct change in performance — this indicates a need for service.

Servicing

Do not attempt to service the set yourself since opening the cabinet may expose you to dangerous voltage or other hazards. Refer all servicing to qualified service personnel.



Replacement Parts

When replacement parts are required, be sure the service technician certifies in writing that he has used replacement parts specified by the manufacturer that have the same characteristics as the original parts. Unauthorized substitutions may result in fire, electric shock, or other hazards.



Safety Check

Upon completion of any service or repairs to the set, ask the service technician to perform routine safety checks (as specified by the manufacturer) to determine that the set is in safe operating condition, and to so certify. When the set reaches the end of its useful life, improper disposal could result in a picture tube implosion. Ask a qualified service technician to dispose of the set.



Contents

Introduction

Introducing the FD Trinitron WEGA Features.....	1
About this Manual.....	2
Batteries for the Remote Control.....	2
Front Panel Menu Controls.....	2

Using the Remote Control

Remote Control Description.....	3
Programming the Remote Control.....	5
Using your TV Remote Control with Other Equipment.....	7

Connecting Your TV

TV Rear Panel.....	9
Basic Connections.....	11
Connecting Additional Equipment.....	12

Using Basic Functions

Setting Up the TV.....	19
Quick Start to the Menus.....	20

Using the Menus

How to Access Menus.....	23
Using the Video Menu.....	24
Using the Audio Menu.....	25
Using the Channel Menu.....	27
Using the Parent Menu.....	29
Parental Control.....	30
United States: Selecting Custom Rating Options.....	32
Canada: Selecting Custom Rating Options.....	34
Using the Timer Menu.....	35
Using the Setup Menu.....	36

Other Information

Troubleshooting.....	37
Specifications.....	41

Index	43
--------------------	-----------

Introduction

Congratulations on your purchase of the Sony FD Trinitron WEGA®.

Introducing the FD Trinitron WEGA® Features

Some of the features you will enjoy include:

- ❑ **FD Trinitron Flat CRT** — Delivers a picture with uncompromising accuracy and outstanding image detail via a technologically advanced tube.
- ❑ **Y, P_B, P_R Inputs** — Provides component video inputs for superior picture quality (480i only).
- ❑ **Surround** — Simulates theater quality sound for stereo programs.
- ❑ **Parental Control (V-Chip)** — Helps parents monitor what their children watch on TV by establishing rating limits.
- ❑ **Favorite Channels** — Provides instant access to your favorite channels with the touch of a button.
- ❑ **Universal Remote Control** — Operates your connected cable box, VCR, digital satellite receiver, or DVD player.
- ❑ **Energy Star®** — Meets the Energy Star guidelines for energy efficiency.
- ❑ **Front Panel Controls** — Allows access to the on-screen menus without the use of a remote control.
- ❑ **Front A/V Inputs** — Lets you quickly connect video games, camcorders or stereo/mono equipment.
- ❑ **16:9 Enhanced** — Provides enhanced picture resolution for wide-screen sources such as DVD.

About this Manual

This manual provides instructions to help you enjoy your new TV. It shows you how to connect to an antenna or cable, cable box, VCR, DVD, satellite receiver, stereo system, or camcorder. Once your TV is connected, follow the instructions and use the remote control to access the on-screen menus.

Batteries for the Remote Control

Insert two AA (R6) batteries (supplied) into the remote control using the following illustration as a guide.

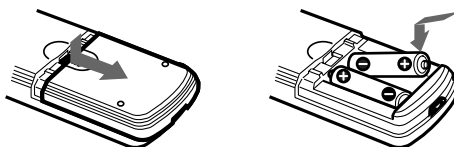



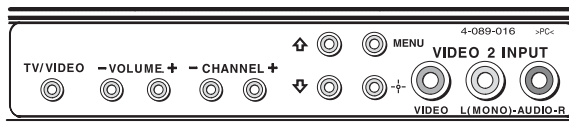

 Under normal conditions, batteries will last up to six months. If the remote control does not operate properly, the batteries might be worn out.

 If you will not be using the remote control for an extended period of time, remove the batteries to avoid possible damage from battery leakage.

Front Panel Menu Controls



The front Audio/Video panel controls allow you to access the menu without the remote control.



- Press  to display the on-screen menu.
- Use the  and  buttons on the front Audio/Video panel instead of your remote control.
- Use the  button on the front Audio/Video panel to navigate through the menus, then select an item. The front panel controls also allow you to change your channels (CH+/-), adjust the volume (VOL +/-), and change video inputs.

 To navigate the menus with your remote control, see "Using the Menus" on page 23.

Using the Remote Control

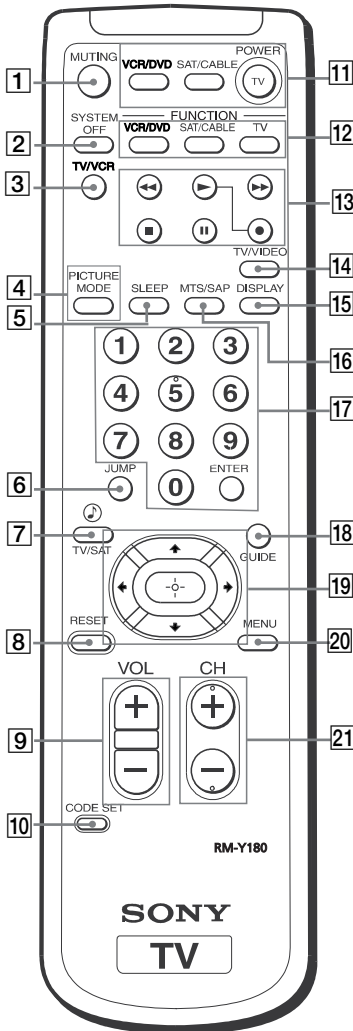
Remote Control Description



Button	Description
1 MUTING	Press to turn off the sound. Press again or press  to restore sound.
2 SYSTEM OFF	Press to turn off the equipment programmed into the remote control. See "Programming the Remote Control" on page 5.
3 TV/VCR	Press to switch between TV and VCR mode. If you have a non-Sony VCR, you will need to program the remote control to recognize your VCR. For details; see "Programming the Remote Control" on page 5.
4 PICTURE MODE	Press repeatedly to step through the available video picture modes: Vivid, Standard, Movie and Sports. Also available in the Video menu. See "Using the Video Menu" on page 24 for details.
5 SLEEP	Press repeatedly until the TV displays the time in minutes (15, 30, 45, 60, or 90) that you want the TV to remain on before shutting off automatically. Cancel by pressing until Sleep Off appears.
6 JUMP	Press to jump back and forth between two channels. The TV alternates between the current channel and the last channel that you selected. JUMP will not work if any FUNCTION Mode (VCR/DVD, SAT/CABLE, TV) is activated.
7 TV/SAT	Press to switch between the TV and SAT (satellite) inputs when in SAT FUNCTION mode.
	Press for a direct selection of Effect settings (Surround, Off) when the remote is in TV FUNCTION mode. See "Using the Audio Menu" on page 25 for details.
8 RESET	Press to return to factory settings while in an on-screen menu.
9 VOL (volume)	Press (+) or (-) to adjust the volume.
10 CODE SET	Press to program your remote control to operate connected video equipment. See "Programming the Remote Control" on page 5.
11 POWER buttons	Press to turn on and off the TV and other audio/video equipment you have programmed into the remote control. For instructions, see "Programming the Remote Control" on page 5.

Button	Description
12 FUNCTION buttons	Press to select the equipment (VCR/DVD, SAT/CABLE, TV) that you want to operate with the remote control. The indicator (LED) lights up momentarily when pressed to show which device the remote control is operating.
13 VCR (operating)	Press to operate your VCR. The VCR must be programmed into the remote control. For instructions, see "Programming the Remote Control" on page 5.
● and ► (to record)	Press the ● button and the ► button at the same time to record programs with your VCR. The remote control must be programmed before you can use REC.
◀◀	Rewind.
▶▶	Fast-forward.
▶	Play.
■	Stop.
 	Pause. Press again to resume normal playback.
14 TV/VIDEO	Press to cycle through available video inputs.
15 DISPLAY	Press once to display the current time (if set) and the program status such as channel number, Channel Label (if set), video input, and Video Label (if set). Press again to turn off the display.
16 MTS/SAP	Press to cycle through the Multi-channel TV Sound (MTS) options: Stereo, Auto SAP (Second Audio Programming), and Mono.
17 0-9 and ENTER	Press to change channels. The channel changes after two seconds.
18 GUIDE	Press to display the program guide of your satellite antenna.
19 	Press the arrow buttons to move the cursor in the on-screen menu. Press the center button to select an option.
20 MENU	Press to display the on-screen menu. Press again to exit the menu at any time.
21 CH (channel)	Press to change channels. To scan rapidly through the channels, press and hold down the CH+ or CH- button.

 If you lose your remote control, see page 38.



Programming the Remote Control

In order to use your remote control with other equipment, you need to program your remote control. Use the following procedure to program the remote control.



1 Check the list of “Manufacturer’s Codes” on page 6 and find the three-digit code number for the manufacturer of your component. If more than one code number is listed, use the number listed first.

2 Press .

 The  and  button will flash when you press .

3 Press  or  button to indicate the type of component you want to program with the remote control.

 You must do step 4 within 10 seconds of step 3, or you must redo steps 2 and 3.

4 Use the - buttons to enter the three-digit manufacturer’s code number.

5 Press .

6 To check if the code number works, aim the TV’s remote control at the component and press on the green POWER button (VCR/DVD, SAT/CABLE, TV) that corresponds with that component. If it responds, you are done. If not try using another code listed for that manufacturer.

 If you have problems programming your remote control, see “Troubleshooting” on page 38.

Manufacturer's Codes

VCRs

<i>Manufacturer</i>	<i>Code</i>
Sony	301, 302, 303
Admiral (M. Ward)	327
Aiwa	338, 344
Audio Dynamic	314, 337
Broksonic	319, 317
Canon	309, 308
Citizen	332
Craig	302, 332
Criterion	315
Curtis Mathes	304, 338, 309
Daewoo	341, 312, 309
DBX	314, 336, 337
Dimensia	304
Emerson	319, 320, 316, 317, 318, 341
Fisher	330, 335
Funai	338
General Electric	329, 304, 309
Go Video	322, 339, 340
Goldstar	332
Hitachi	306, 304, 305, 338
Instant Replay	309, 308
JC Penney	309, 305, 304, 330, 314, 336, 337
JVC	314, 336, 337, 345, 346, 347
Kenwood	314, 336, 332, 337
LXI (Sears)	332, 305, 330, 335, 338
Magnavox	308, 309, 310
Marantz	314, 336, 337
Marta	332
Memorex	309, 335
Minolta	305, 304
Mitsubishi/ MGA	323, 324, 325, 326
Multitech	325, 338, 321
NEC	314, 336, 337

<i>Manufacturer</i>	<i>Code</i>
Olympic	309, 308
Optimus	327
Panasonic	308, 309, 306, 307
Pentax	305, 304
Philco	308, 309
Philips	308, 309, 310
Pioneer	308
Quasar	308, 309, 306
RCA/ PROSCAN	304, 305, 308, 309, 311, 312, 313, 310, 329
Realistic	309, 330, 328, 335, 324, 338
Sansui	314
Samsung	322, 313, 321
Sanyo	330, 335
Scott	312, 313, 321, 335, 323, 324, 325, 326
Sharp	327, 328
Shintom	315
Signature 2000 (M. Ward)	338, 327
SV2000	338
Sylvania	308, 309, 338, 310
Symphonic	338
Tashiro	332
Tatung	314, 336, 337
Teac	314, 336, 338, 337
Technics	309, 308
Toshiba	312, 311
Wards	327, 328, 335, 331, 332
Yamaha	314, 330, 336, 337
Zenith	331

Laserdisc Players

<i>Manufacturer</i>	<i>Code</i>
Sony	701
Panasonic	704, 710
Pioneer	702

DVD Players

<i>Manufacturer</i>	<i>Code</i>
Sony	751
Hitachi	758
JVC	756
Magnavox	757
Mitsubishi	761
Onkyo	762
Oritron	759
Panasonic	753
Philips	757
Pioneer	752
RCA	755
Samsung	758
Toshiba	754
Zenith	760

Cable Boxes









<i>Manufacturer</i>	<i>Code</i>
Sony	230
Hamlin/Regal	222, 223, 224, 225, 226
Jerrold/G.I./ Motorola	201, 202, 203, 204, 205, 206, 207, 208, 218
Oak	227, 228, 229
Panasonic	219, 220, 221
Pioneer	214, 215
Scientific Altanta	209, 210, 211
Tocom	216, 217
Zenith	212, 213

Satellite Receivers









<i>Manufacturer</i>	<i>Code</i>
Sony	801
DIRECT TV	809
Dish Network	810
Echostar	810
General Electric	802
Hitachi	805
Hughes	804
Mitsubishi	809
Panasonic	803
RCA/ PROSCAN	802, 808
Toshiba	806, 807

Using your TV Remote Control with Other Equipment





Operating a VCR

Press	To
	Power on the VCR (VCR/DVD green button)
	Select a channel
	Change channels
	Play video tape
	Stop
	Search forward or backward
	Pause
	Record
	Switch between VCR and TV inputs

Operating a DVD Player









Press	To
	Power on the DVD (VCR/DVD green button)
	Select chapters
	Search chapters forward or backward
	Play DVD
	Stop
	Pause
	Display the DVD menu
	Use the arrow buttons to move the cursor in the menu, and the center button to select an option

Operating a Laser Disc Player





Press	To
	Power on the laser disc (VCR/DVD green button)
	Search chapters forward or backward
	Play disc
	Stop
	Pause

Operating Instructions

Operating a Satellite Receiver

Press	To
	Power on the satellite receiver (SAT/CABLE green button)
	Select a channel
	Change channels
	Back to previous channel
	Display channel number
	Display SAT GUIDE
	Display SAT Menu
	Use the arrow buttons to move the cursor in the menu, and the center button to select an option

Operating a Cable Box

Press	To
	Power on the cable box (SAT/CABLE green button)
	Select a channel
	Change channels
	Change back to previous channel

Connecting Your TV

Read this section before setting up your TV for the first time. This section explains how to make the basic connections and how to connect optional equipment.

TV Rear Panel

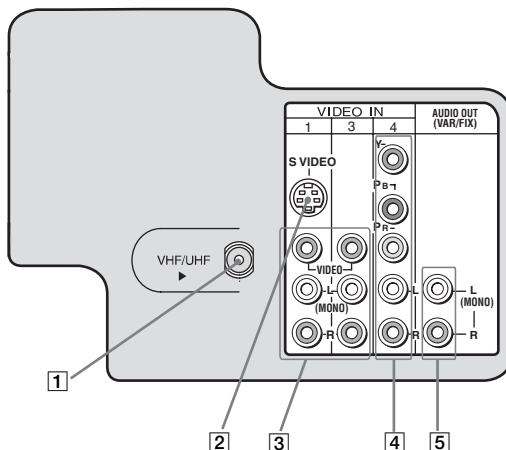

Jack	Description
1 VHF/UHF	This input connects to your VHF/UHF antenna or cable.
2 S VIDEO	This input connects to the S VIDEO OUT jack on your VCR or other video equipment that has S VIDEO. S VIDEO provides better picture quality than the VHF/UHF jacks or the video input jack. S VIDEO does not provide sound, so you still must connect the audio cables.
3 AUDIO L(MONO), R/ VIDEO	This input connects to the AUDIO/VIDEO output jacks on your VCR or other video equipment. A third video input jack (VIDEO 2) is located on the front panel of the TV. These AUDIO/VIDEO input jacks provide better picture quality than the VHF/UHF jack.

Operating Instructions

Jack	Description
4 Y, P _B , P _R / L, R	These inputs (Video 4) connect to the component video Y, P _B , P _R , and AUDIO L, R jacks on your DVD player or digital set-top box (480i only).
5 AUDIO OUT (VAR/FIX) L, R	This jack connects to the Audio input jacks on your audio equipment. You can listen to your TV's audio through your stereo system.

Basic Connections

TV with Cable, Indoor, or Outdoor Antenna

Depending on the cable system available in your home, choose one of the connections below:

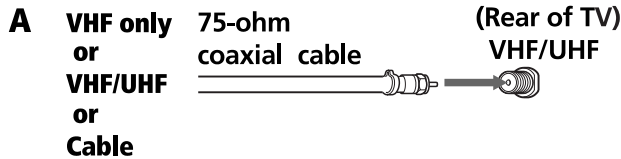

Use this to connect the TV to a cable system or an antenna with a 75-ohm cable (usually built in to newer homes).

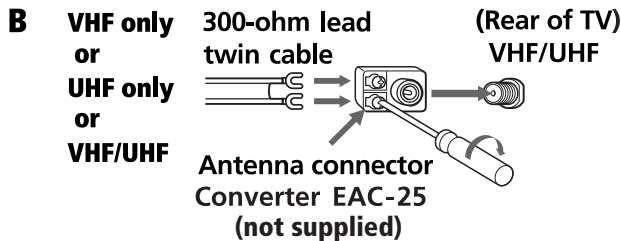

Use this to connect the TV to a dipole antenna, also known as a “rabbit ears antenna” (usually found in older homes).

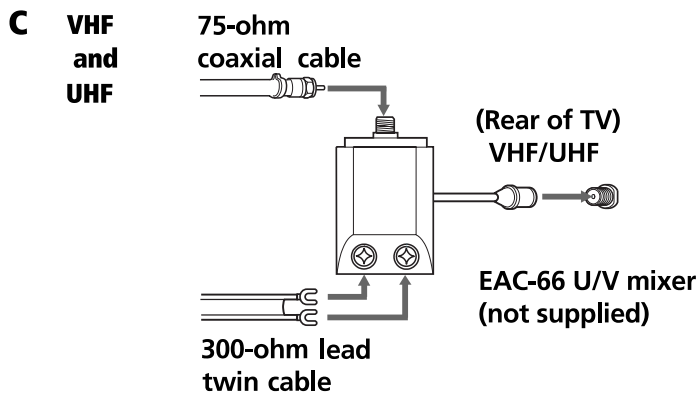

This allows you to connect your TV to both a cable system and a dipole antenna, in order to view both cable and local channels.

 If you are connecting to an indoor or outdoor antenna, you may need to adjust the orientation of the antenna for the best reception.

Connecting Additional Equipment

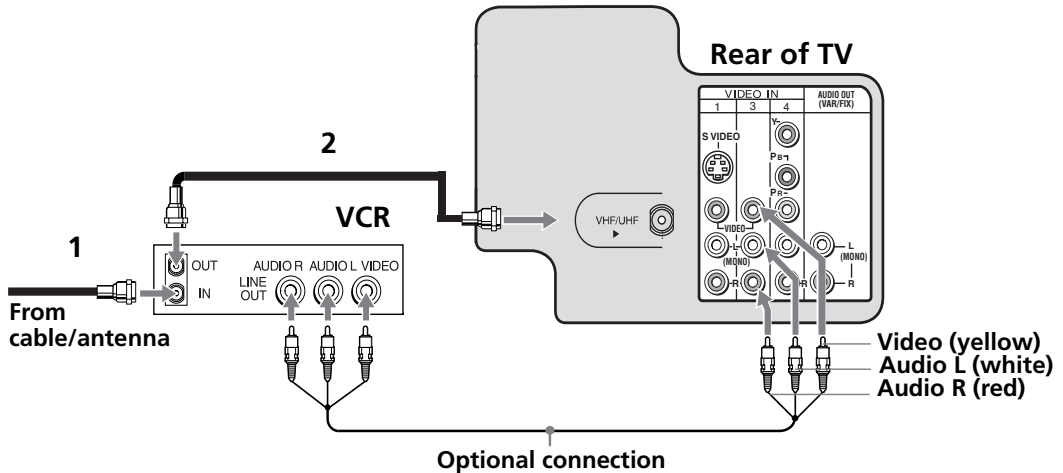

Connecting a TV and VCR



- 1** Connect the coaxial cable from your TV antenna or cable service to the IN jack on your VCR.
- 2** Connect a coaxial cable (not supplied) from the OUT jack on your VCR to the VHF/UHF jack on the TV.

Using your TV with this connection

This connection allows you to do the following:

- ❑ Program your Sony remote control to operate your VCR (see page 5).
- ❑ To activate your remote, press  to operate your VCR. To do this, first program your remote control, then use the Channel Fix feature to set your TV to channel 3 or 4 (see page 27).
- ❑ Press  repeatedly to switch between VCR input (VIDEO input) and VHF/UHF (local channels).

Optional connection

- ❑ If your VCR is equipped with video outputs, you can get better picture quality by connecting audio/video cables (not supplied) from AUDIO/VIDEO OUT on your VCR to AUDIO/VIDEO IN on your TV.
- ❑ For better picture quality, use S VIDEO instead of the yellow video cable. S VIDEO does not provide sound, so you still must connect the audio cables.

TV and Cable Box

Some cable TV systems use scrambled or encoded signals that require a cable box to view all channels. If you subscribe to that kind of cable service, use this connection. If some, but not all, of your channels are scrambled, consider using the cable box and cable connection (see page 12).

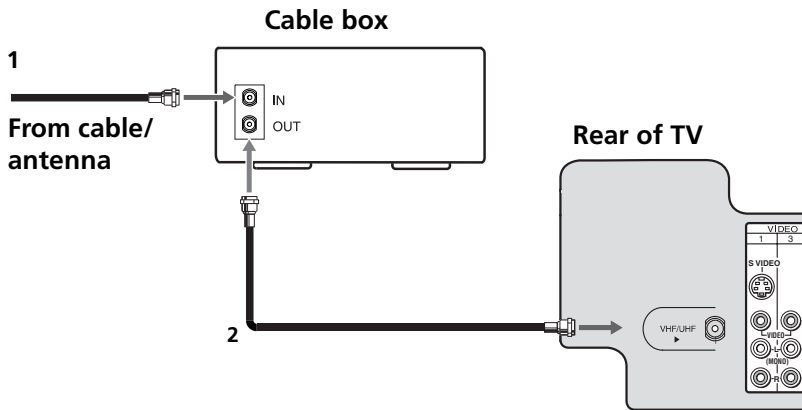

- 1** Connect the coaxial cable from your cable service to the IN jack on your cable box.
- 2** Connect a coaxial cable (not supplied) from the OUT jack on your cable box to the VHF/UHF jack on your TV.

Using your TV with this connection

This connection allows you to do the following:

- Program your Sony remote control to operate your cable box (see page 5).
- To activate your remote press  to operate your cable box and then use the **0-9** buttons or CH+/- buttons to change the channels. To do this, first program your remote control, then use the Channel Fix feature to set your TV to channel 3 or 4 (see page 27).

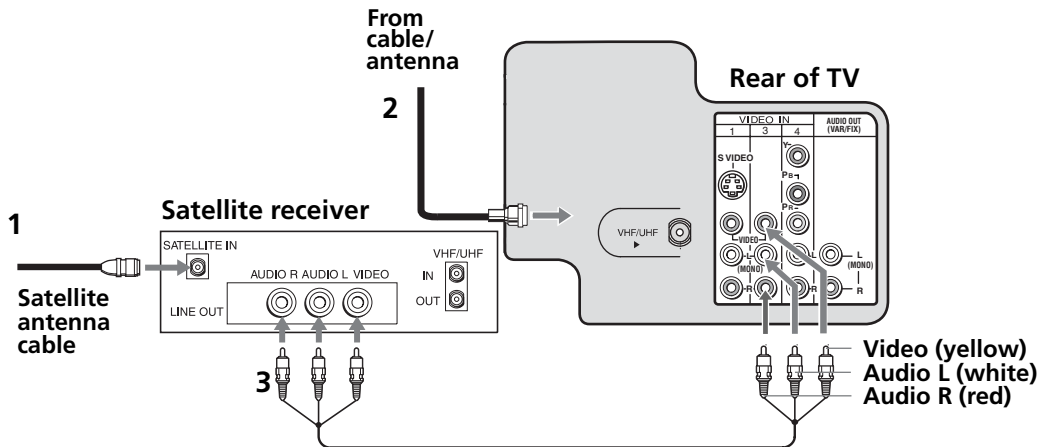

Connecting a TV and Satellite Receiver



- 1** Connect the cable from your satellite antenna to SATELLITE IN on your satellite receiver.
- 2** Connect the coaxial cable from your cable service or antenna to the VHF/UHF jack on your TV.
- 3** Using audio/video cables (not supplied), connect AUDIO/VIDEO OUT on your satellite receiver to AUDIO/VIDEO IN on your TV.

Using your TV with this connection

This connection allows you to do the following:

- ❑ Program your Sony remote control to operate your satellite receiver (see page 5).
- ❑ To activate your remote, press  to operate your satellite receiver. See page 7 on how to operate other functions.
- ❑ Press  repeatedly to switch to satellite receiver input (VIDEO input).

Connecting a TV, VCR, and Satellite Receiver

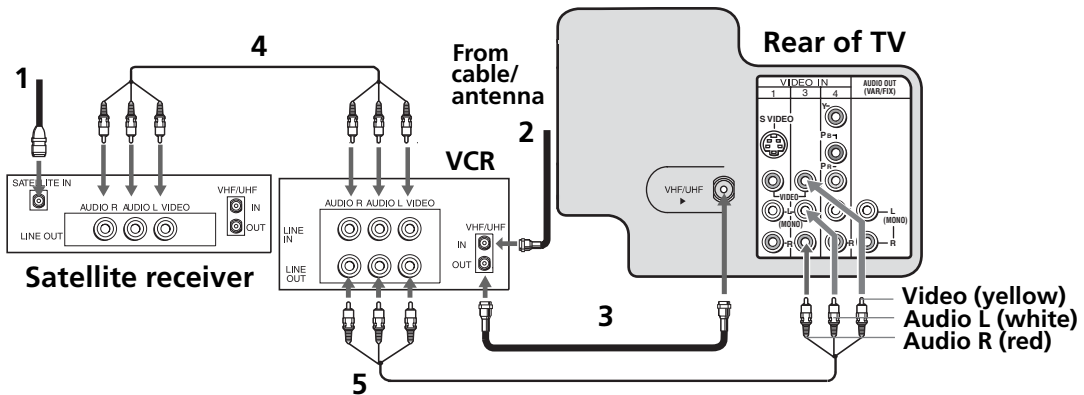

- 1** Connect the coaxial cable from your satellite antenna to SATELLITE IN on the satellite receiver.
- 2** Connect the coaxial cable from your cable service or antenna to the IN jack on your VCR.
- 3** Using a coaxial cable (not supplied), connect the OUT jack on your VCR to the VHF/UHF jack on your TV.
- 4** Using audio/video cables (not supplied), connect AUDIO/VIDEO OUT on your satellite receiver to AUDIO/VIDEO IN on your VCR.
- 5** Using audio/video cables (not supplied), connect AUDIO/VIDEO OUT on your VCR to AUDIO/VIDEO IN on your TV.

To view from the satellite receiver or VCR, select the video input to which your satellite receiver or VCR is connected by pressing on the remote control.

Using your TV with this connection

This connection allows you to do the following:

- Program your Sony remote control to operate your VCR or satellite receiver (see page 5).
- Turn on your VCR to enable your satellite receiver to work with this connection.
- To activate your remote, press to operate your VCR or to operate your satellite receiver.
- Press repeatedly to switch between VCR input (VIDEO input), VHF/UHF (local channels or unscrambled), or your cable box (cable system or scrambled channels).

Connecting a DVD Player

Using audio/video cables (not supplied), connect AUDIO/VIDEO OUT on your DVD player to AUDIO/VIDEO IN on your TV.

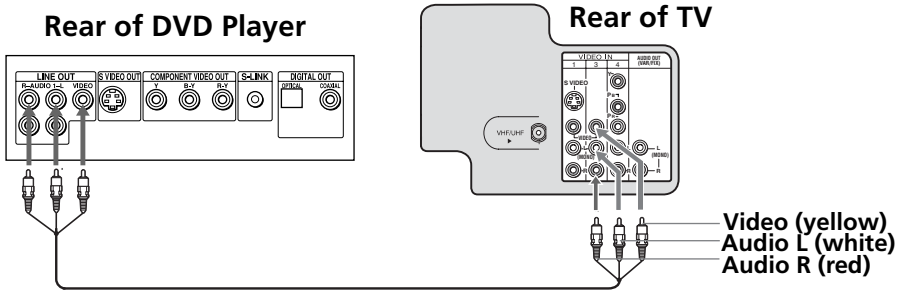

Optional connection

- ❑ For better picture quality, use S VIDEO instead of the yellow video cable. S VIDEO does not provide sound, so you still must connect the audio cables.
- ❑ If your DVD player is equipped with component video outputs (Y, P_B, P_R), you can improve the picture quality by using component video cables (480i only).

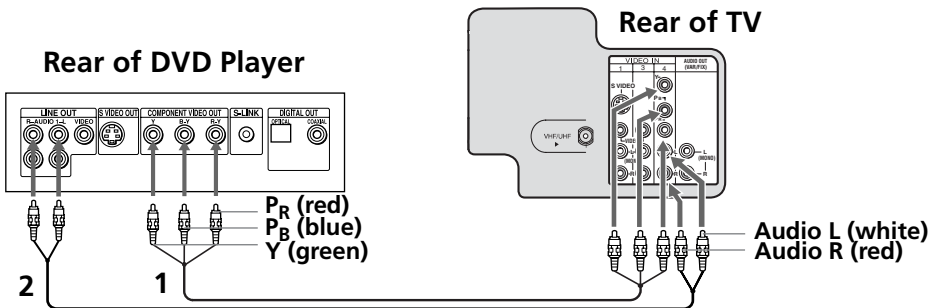

- 1** Using component video cables (not supplied), connect the Y, P_B, P_R OUT on your DVD player to Y, P_B, P_R IN on your TV.
- 2** Connect AUDIO OUT on your DVD player to AUDIO IN on your TV.

The Y, P_B, P_R outputs on your DVD player are sometimes labeled Y, C_B, and C_R or Y, B-Y, and R-Y. If so, connect the cables to like colors.

Using your TV with this connection

This connection allows you to do the following:

- ❑ Program your Sony remote control to operate your DVD (see page 5).
- ❑ To activate your remote, press to operate your DVD.
- ❑ Press repeatedly to switch to the DVD player's input (VIDEO input).

Connecting a Camcorder

To connect your camcorder, you can use the Audio/Video inputs on either the front or rear panel of the TV. Using the audio/video cables (not supplied), connect the AUDIO/VIDEO OUT on your camcorder to the AUDIO/VIDEO IN on your TV.

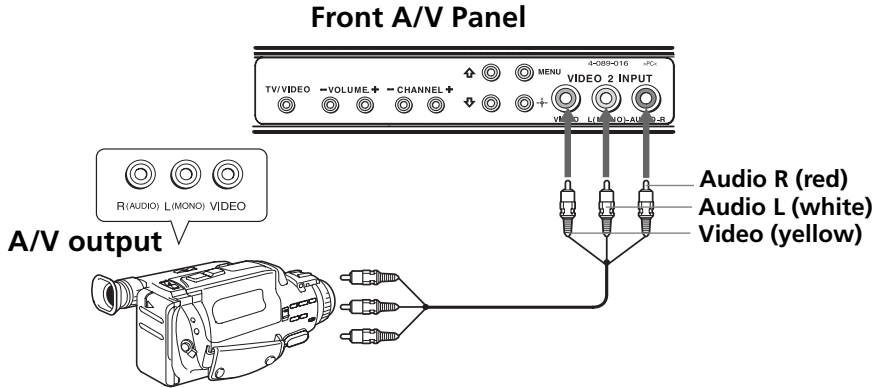

Connecting an Audio System

- 1** Using audio/video cables (not supplied), connect AUDIO OUT on your TV to one of the unused line inputs (e.g. TV, AUX, TAPE2) on your stereo.
- 2** Set the Speaker option to Off. For more instructions, see "Using the Audio Menu" on page 25.
- 3** Open the Audio Out option on the Audio Menu and select Fixed to control the volume through the connected audio system. For more instructions, see "Using the Audio Menu" on page 25.

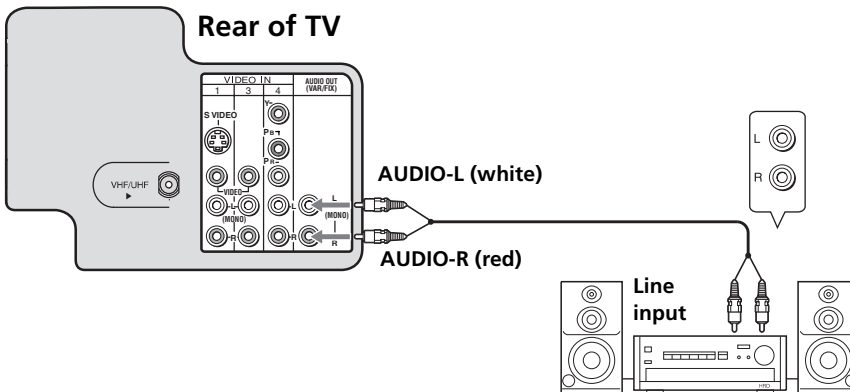

Using Basic Functions

Setting Up the TV

After you have finished connecting your TV, you can use Auto Program to set up your channels. During Auto Program, the TV will automatically search for available channels and program receivable channels.

 When you start Auto Program wait until it is finished; otherwise it will skip over channels that are available. Perform Auto Program again to program receivable channels.



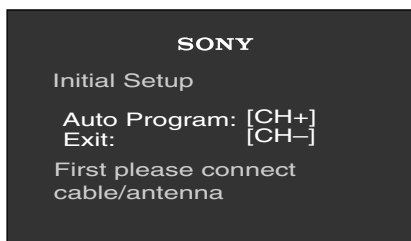







- 1 Press  to turn on the TV. The Initial Setup screen appears.





- 2 Press  on the remote control or on the TV front panel to start Auto Program, or press  to exit.

 The Initial Setup screen appears each time you turn on the TV until you perform Auto Program.

To perform Auto Program again



- 1 Press .
- 2 Press  to highlight Channel Menu.
- 3 Press  to highlight Cable. Press  to select.
- 4 Press  or  to highlight On or Off according to how you connected your TV. Press  to select.
- 5 Press  to highlight Auto Program. Press  to search for channels.
- 6 After Auto Program finishes, press  to exit.

To reset the TV to factory settings

- 1 Turn the TV on.
- 2 Hold down  on the remote control.
- 3 Press and release the POWER button on the TV front panel. The TV will turn itself off, then back on.
- 4 Release .

Quick Start to the Menus

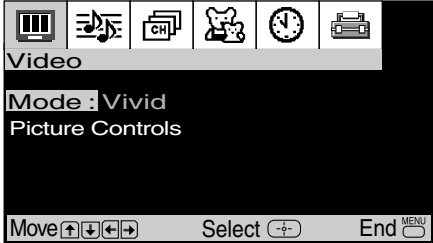
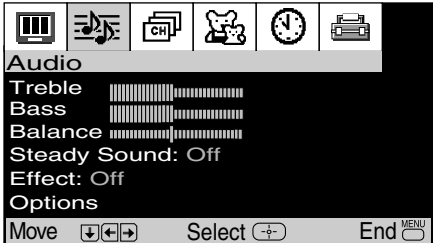
The following settings are available in your on-screen menus. For more details on how to use the menus, see “Using the Menus” on page 23.

Menu	Allows you to
	Adjust your picture settings.
	Change your audio settings.
	Customize your channel settings.
	Set rating limits on your TV based on program rating or content.

Menu

Allows you to



Set the clock on your TV and program scheduled viewing using Timer 1 and Timer 2.









Select closed captioning options, label video inputs, adjust tilt correction, enhance your DVD picture resolution (16:9 Enhanced), select menu language, or run a demo of the menus.



Using the Menu

This section shows the options available for setting up and adjusting the TV.

How to Access Menu

To Access Menu

- 1** Press  to display the on-screen menu.
- 2** Use the  or  buttons to highlight the desired menu icon. Press  to select it.
- 3** Use the  or  buttons to scroll up and down through the features.
- 4** Follow the instructions on the screen.
- 5** For instructions on using a specific menu, see the page in this section that talks about that menu.
- 6** Press  to exit the menu.

 Press  once to display the on-screen menu, and press again to return to normal viewing. If no buttons are pressed, the menu closes automatically after about 90 seconds.

Using the Video Menu



To access the Video menu, use the following steps:

To Display







To Select

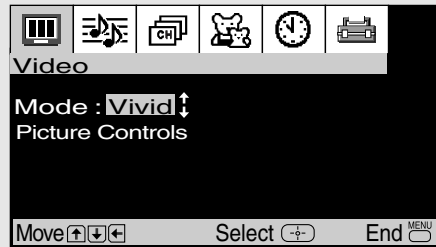



Press  to highlight an option; then press .







- Mode** Use the  or  buttons to highlight one of the following options, then press  to select it.
- Customized picture viewing* **Vivid:** Select for enhanced picture contrast and sharpness.
 - Standard:** Select for a standard picture.
 - Movie:** Select for a finely detailed picture.
 - Sports:** Select for a bright picture.



 Press  on the remote control for direct access to the picture modes (Vivid, Standard, Movie, Sports).



Picture Controls



With the Picture Controls menu open, press  or  to select one of the following options:



Picture Press  to decrease the contrast. Press  to increase the contrast.

Brightness Press  to darken the picture. Press  to brighten the picture.

Color Press  to decrease color saturation. Press  to increase color saturation.

Hue Press  to increase the red tones. Press  to increase the green tones.



Sharpness Press  to soften the picture. Press  to sharpen the picture.

Color Temp. Use the  or  buttons to highlight one of the following options, then press  to select it.

White tint adjustment **Cool:** Gives white colors a blue tint.

Neutral: Gives white colors a neutral tint.

Warm: Gives white colors a red tint.



VM Sharpens picture definition to give objects a crisp, clean edge. Use the  or  buttons to highlight one of the following options: **High**, **Low**, **Off**, then press  to select it.

Using the Audio Menu











To access the Audio menu, use the following steps:

To Display **To Highlight**  **To Select**





Press  to highlight an option; then press .



Treble	Press  to decrease the higher pitched sounds. Press  to increase the higher pitched sounds.
Bass	Press  to decrease the lower pitched sounds. Press  to increase the lower pitched sounds.
Balance	Press  to emphasize the left speaker. Press  to emphasize the right speaker.
Steady Sound <i>Stabilizes volume</i>	Press  or  to select one of the following options: On: Select to stabilize the volume when changing channels. Off: Select to turn Steady Sound off.
Effect	Use the  or  buttons to highlight one of the following options, then press  to select it. Surround: Simulates theater quality sound for stereo programs. Off: Normal stereo or mono reception.

 Press  to directly select Effect settings (Surround, Off).

Options	Use these features to change your Audio setting.
MTS <i>Multi-Channel TV Sound</i>	Use the  or  buttons to highlight one of the following options, then press  to select it. Stereo: Select when viewing a broadcast in stereo. Auto SAP: Select to have the TV automatically switch to a Second Audio Program (SAP) when a signal is received. Mono: Select to reduce noise in areas of poor reception.

 Press  to directly select MTS settings (Stereo, Auto SAP, Mono).

 If your TV is set to Auto SAP, some programs may be muted or distorted. If your TV does not output sound, change your Audio MTS setting to Stereo or Mono.

Speaker

*Custom
selection of
audio output
source*

Use the \uparrow or \downarrow buttons to highlight one of the following options, then press \rightarrow to select it.

On: Select to listen to the sound from the TV speakers with or without a separate stereo system.

Off: Select to turn off the TV speakers and listen to the TV's sound only through external audio system speakers.

Audio Out

*Use to control
the TV's volume
through a
stereo*

Use the \uparrow or \downarrow buttons to highlight one of the following options, then press \rightarrow to select it.

Variable: Adjust the volume through your TV.





Fixed: Adjust the volume through a connected stereo.





You can only set Audio Out settings when you have set Speaker to Off.

Using the Channel Menu









To access the Channel menu, use the following steps:





<p>To Display</p> 	<p>To Highlight </p> 	<p>To Select</p> 	
--	--	---	--

Press  to highlight an option; then press .



Favorite Channels

Quick access to favorite channels

- 1 Use the  or  buttons to highlight the position (1-5) where you want to set a favorite channel, then press .
- 2 Use the  or  buttons to find the channel you want to add to your favorite channels.
- 3 Press  to select the channel. The TV will automatically change to the selected channel.
- 4 Press  to return to the Channel menu or press  to exit.

 To use Favorite Channels, exit all menus and press . Press  or  to move the cursor to the desired channel number and press .

Cable



Use the  or  buttons to highlight one of the following options, then press  to select it.

On: Select if you are receiving cable channels with a CATV cable.

Off: Select if you are using a TV antenna.

 After changing your cable settings, you will need to perform Auto Program. See "To perform Auto Program again" on page 19.

Channel Fix











Use the  or  buttons to highlight one of the following options, then press  to select it.









Off: Channel Fix is not set.



2-6: Select when you want to control all channel selection through a cable box or VCR. Select the appropriate channel (usually 3 or 4) and use the cable box's or VCR's remote control for channel selection.













Video 1: Select from available video inputs when you have connected video equipment (e.g., a satellite receiver) and you want your TV fixed to it.

 You cannot use Favorite Channels, Cable, Channel Skip/Add, or Channel Label when Channel Fix is set.

-
- Auto Program** Perform Auto Program whenever setting up your TV.
Auto Program will search for available channels and program receivable channels.
- 1 Press .
 - 2 Press  to highlight Channel menu.
 - 3 Press  to highlight Cable. Press  to select.
 - 4 Press  or  to highlight On or Off according to how you connected your TV. Press  to select.
 - 5 Press  to highlight Auto Program. Press  to search for channels.
 - 6 After Auto Program finishes, press  to exit.
-

- Channel Skip/Add** Use this feature after you run Auto Program to skip unwanted channels or add new ones.
- 1 Use the  or  buttons to highlight the position of the desired channel, then press .
 - 2 Use the  or  buttons to highlight **Skip** or **Add**, then press .
 - 3 Press  to return to the Channel menu or press  to exit.

 Press CH + or CH - to skip over channels that have been skipped. You can still use the  buttons to directly tune to skipped channels.

- Channel Label**
Label up to 40 channels with their call letters
- 1 Press , then use the  or  buttons until you reach the desired channel number.
 - 2 Press  to activate the channel.
 - 3 Press  to highlight **Label**, then press . Use the  or  buttons to display the first call letter or number of the label. Press  to select. Repeat this process until you finish selecting all the call letters.
 - 4 When finished, press  to activate.
 - 5 Press  to return to the Channel menu or press  to exit.
-

Using the Parent Menu

To access the Parent menu, use the following steps:



The Parental Control feature helps parents monitor what their children watch on television.

To use the Parent Menu

When you select the Parent menu, you are prompted to set a 4-digit password. You cannot access the Parent menu settings without this password.

- 1** Use the **0**-**9** buttons to enter a 4-digit password.
- 2** Confirm your password by entering it again.

 Keep this manual in a safe place. You need your password for any future access to the Parent menu. If you forget your password, see page 37.

Parental Control

Setting the Rating

You can change the Rating by selecting one of the Parental Lock options.



- 1 Press ∇ to highlight **Parental Lock**; then press \oplus .

If you are not familiar with Parental Guideline rating system, use one of the following preset categories to simplify the rating selection: Child, Youth, Young Adult.

- 2 Use the \uparrow or \downarrow to highlight the desired rating and press \oplus .

Rating	TV will allow a maximum rating of
Off	No rating limit
Child	TV-Y, TV-G, G (U.S.), G, C (Canada)
Youth	TV-PG, PG (U.S.), 8 ans + (Canada)
Young Adult	TV-14, PG-13 (U.S.), 14+ (Canada)
Custom	Select to set more restrictive ratings (see next section)

Changing your Password

- 1 Use the \uparrow or \downarrow buttons to highlight **Change Password** and press \oplus .
- 2 Follow steps 1 and 2 for “Using the Parent Menu” on page 29.



Select a Country

Select U.S.A. to use US ratings (see pages 32-33) or select Canada to use Canadian ratings (see page 34). If you select a country (U.S.A or Canada) different from your actual location then some programs may contain ratings that will not be able to be blocked.

- 1 Press ∇ to highlight **Country**, then press \oplus .
- 2 Use the \uparrow or \downarrow to highlight the desired country and press \oplus .

Information for Parents

To view a program that exceeds the TV rating

- Press , then use the  buttons to enter your password.

 Entering your password to view a blocked program will temporarily turn **Parental Lock** to Off. To reactivate your Lock settings, turn the TV off then back on; the TV will return to the settings that you have selected.

Using the Custom Menu

Follow the instructions on the screen to make your custom settings. Select the country desired for your TV's rating limit. See page 32 for U.S. models and page 34 for Canadian models for more information.

 Once you have blocked a rating or content, all higher ratings or content will be automatically blocked.

United States: Selecting Custom Rating Options

For the United States, the Custom Rating menu includes the following options: Movie Rating, TV Rating and Unrated. (For Canada, see page 34.)

Movie Rating

This system defines the rating levels of movies shown in theaters and on prime cable channels.

Rating	Defined as
G	General audience
PG	Parental guidance suggested
PG-13	Parents strongly cautioned
R	Restricted
NC-17	No one 17 and under admitted
X	Adult audience only

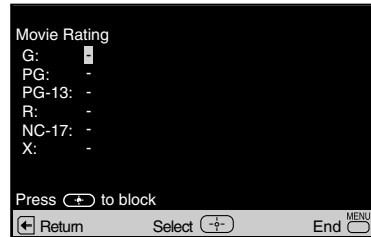

TV Rating

The TV rating is divided into two groups: age-based and content-based.

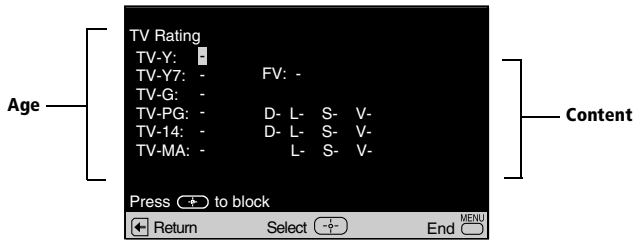

Age	Defined as
TV-Y	All children
TV-Y7	Directed to older children
TV-G	General audience
TV-PG	Parental guidance suggested
TV-14	Parents strongly cautioned
TV-MA	Mature audience only

Content	Defined as
FV	Fantasy violence
D	Suggestive dialogue
L	Strong language
S	Sexual situations
V	Violence

The content ratings will increase depending on the level of the age-based rating. For example, a program with a TV-PG V (Violence) rating may contain moderate violence, while a TV-14 V (Violence) rating may contain intense violence.

Unrated

You have the option of blocking TV programs or movies that are not rated.

Allow	Allows all unrated programs
Block	Blocks all unrated programs



 If you choose to block unrated TV programs, please be aware that the following programs may be blocked: emergency broadcasts, political programs, news, public service announcements, religious programs, and weather.

Canada: Selecting Custom Rating Options

For Canada, the Custom Rating menu includes the following options: English Rating, French Rating, and U.S.A. Rating.

English Rating

These ratings are for Canadian programs that are broadcast in English.

Rating	Defined as
C	Children
C8+	Children 8 years and older
G	General programming
PG	Parental guidance
14+	Viewers 14 and older
18+	Adult programming

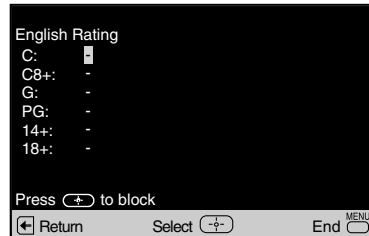

French Rating

These ratings are for Canadian programs that are broadcast in French.

Rating	Defined as
G	General
8 ans+	Not recommended for younger children
13 ans+	Not recommended for children under age 13
16 ans+	Not recommended for ages under 16
18 ans+	This program is restricted to adults

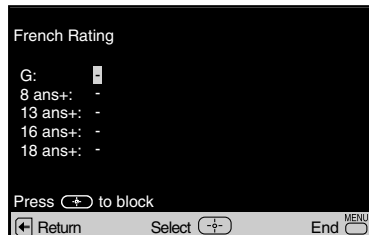

U.S.A. Rating

For programs from the United States, see “TV Rating” on page 32.

Using the Timer 🕒 Menu

To access the Timer menu, use the following steps:

To Display



To Highlight 🕒



To Select



Current Time Set your TV to the current day and time. Press to open the Current Time menu:

- 1 Use the or buttons to enter the correct day and time, then press .
- 2 Press to exit the menu.

You must set the Current Time before you can use Timer 1 or Timer 2.

Timer 1 and Timer 2

*Scheduled
viewing*

Use the timers to program your TV to turn on and off by day, time, duration, and channel. The timer duration is a maximum of six hours. When the channel is fixed, it is not necessary to set the channel.

- 1 Use the or buttons to highlight **Timer 1** or **Timer 2**, then press .
- 2 Use the or buttons to enter the desired day, start time, duration, and channel, then press . The timer status should be On when the Timer has been set, and the timer light on the front panel of the TV should be on.
- 3 Press to exit the menu.

Select Off to turn off the Timer. Your previous settings will be saved.

When you perform Auto Program, Timer 1 and Timer 2 settings will be cleared. Also, in the event of any loss of power, Current Time, Timer 1, and Timer 2 settings will be cleared.

Using the Setup Menu

To access the Setup menu, use the following steps:

To Display





To Highlight 



To Select





Press  to highlight an option; then press .



Caption Vision

Closed-Captioning

Allows you to select from three closed caption modes for programs that are broadcast with closed captioning.

Use the  or  buttons to highlight one of the following options, then press  to select it.

Off: Caption Vision is not activated.

CC1, 2, 3, 4: Displays printed dialogue and sound effects of a program.



Text1, 2, 3, 4: Displays network/station information.



XDS: Displays the name of the current program and its remaining time (if available) when you change the channel or press the DISPLAY button.

Video Label

Label connected equipment



Allows you to identify the video components connected to the TV: VCR, DVD, etc. When you press TV/VIDEO to switch inputs, the Video Label appears on-screen.

1 Press the  or  buttons to highlight the input you want to label and press .

2 Press the  or  buttons to highlight a label and press .



3 Press  to return to the Setup menu or press  to exit.

Tilt Correction

Use the  or  buttons to set the tilt of the picture from -5 to +5, then press  to activate.

Language

Display all menus in the language of your choice.

Use the  or  buttons to select from one of the following options: **English**, **Español** (Spanish) and **Français** (French). Then press .

16:9 Enhanced

Provides enhanced picture resolution for wide-screen sources such as DVD. This is only available when the TV is in Video mode.

Demo

Press  to run a demonstration of the on-screen menus.

 You can press any button to exit Demo mode.

Other Information

Troubleshooting

If you have a problem with your TV, try the suggestions below. If the problem persists, see “Contacting Sony” at the end of this section.

General

Problem	Possible Remedies
I want to reset the TV to the factory settings	<input type="checkbox"/> Turn on the TV. While holding down the RESET button on the remote control, press POWER button on the TV front panel. The TV will turn itself off, then back on again. Release the RESET button.
I lost the parental control password	<input type="checkbox"/> In the password screen, enter the following master password: 4357. After using the master password, you must create a new password. You cannot use the master to unlock currently blocked channels.
There is a black box on the screen	<input type="checkbox"/> You have selected a text option in the Setup menu (page 36) and no text is available. To turn off this feature, select Off in the Caption Vision option. If you were trying to select closed captioning, select CC1-4 instead of Text1-4.
There was a blackout or power outage, and now the TV won't turn on and the timer LED is flashing	<input type="checkbox"/> Unplug the power cord, wait 1 minute to reset TV and plug again then press the POWER button on your remote comander or on the TV front panel.

Remote Control

Problem	Possible Remedies
I cannot operate the remote control	<ul style="list-style-type: none"><input type="checkbox"/> Press TV (FUNCTION) when operating your TV.<input type="checkbox"/> Check the orientation of the batteries.<input type="checkbox"/> Batteries could be weak. Replace them (page 2).<input type="checkbox"/> Move the TV three to four feet away from fluorescent lights.
I cannot change channels with the remote control	<ul style="list-style-type: none"><input type="checkbox"/> Make sure you have not inadvertently switched your TV from the channel 3 or 4 setting if you are using another device to change channels.<input type="checkbox"/> If you are using another device to control channels, be sure that you have pressed the FUNCTION button for that device. For example, if you are using your VCR to control channels, be sure to press the VCR/DVD FUNCTION button (page 4).
I lost the remote control	<ul style="list-style-type: none"><input type="checkbox"/> You can use the front panel controls to access your menus, change channels, adjust the volume, or change video inputs (page 2). Contact your nearest Sony Dealer to order a replacement, please call our Sony Direct Accessory and Part Center at 1-800-488-7669 (U.S. residents only).



Programming The Remote Control

Problem	Possible Remedies
More than one code is listed	<ul style="list-style-type: none"><input type="checkbox"/> Try entering them one by one until you come to the correct code for your component.
I entered the wrong code number	<ul style="list-style-type: none"><input type="checkbox"/> If you enter a new code number, the code number you previously entered at that setting is erased.
I cannot operate a component with the remote control	<ul style="list-style-type: none"><input type="checkbox"/> Use the component's own remote control.
When I changed the batteries, the code numbers changed back to the factory settings	<ul style="list-style-type: none"><input type="checkbox"/> You must reprogram the remote control.

Video

Problem	Possible Remedies
No picture, no sound	<ul style="list-style-type: none"> <input type="checkbox"/> Make sure the power cord is plugged in. <input type="checkbox"/> If a red light is flashing on the front of your TV for more than a few minutes, disconnect and reconnect the power cord. If the problem continues, call your local service center. <input type="checkbox"/> Check the TV/VIDEO setting: when watching TV, set it to TV; when watching video equipment, set it to VIDEO 1, 2, 3 or 4 (page 4). <input type="checkbox"/> Make sure you have inserted the batteries correctly into the remote control (page 2). <input type="checkbox"/> Try another channel to rule out station trouble.
Poor or no picture, good sound	<ul style="list-style-type: none"> <input type="checkbox"/> Adjust the Picture setting in the Video menu (page 24). <input type="checkbox"/> Adjust the Brightness setting in the Video menu (page 24). <input type="checkbox"/> Check the antenna and/or cable connections (page 11).
No color	<ul style="list-style-type: none"> <input type="checkbox"/> Adjust the Color setting in the Video menu (page 24).
Only snow appears on the screen	<ul style="list-style-type: none"> <input type="checkbox"/> Check the Cable setting in the Channel menu (page 27). <input type="checkbox"/> Check the antenna and/or cable connections (page 11). <input type="checkbox"/> Make sure the channel selected is currently broadcasting.
Dotted lines or stripes	<ul style="list-style-type: none"> <input type="checkbox"/> Adjust the antenna. <input type="checkbox"/> Move the TV away from other electronic equipment. Some electronic equipment creates electrical noise, which can interfere with TV reception.
Double images or ghosts	<ul style="list-style-type: none"> <input type="checkbox"/> Check your outdoor antenna or call your cable service.

Audio

Problem	Possible Remedies
Good picture, no sound	<ul style="list-style-type: none"> <input type="checkbox"/> Press  so that Muting disappears from the screen (page 3). <input type="checkbox"/> Check your Audio settings. Your TV may be set to Auto SAP in the MTS feature (page 25). <input type="checkbox"/> Make sure the speaker option is set to On in the Audio Menu. <input type="checkbox"/> Press  to adjust your TV's volume.

Channels

Problem	Possible Remedies
I cannot receive higher number channels (UHF) when using an antenna	<ul style="list-style-type: none"><input type="checkbox"/> Make sure Cable is set to Off in the Channel menu (page 27).<input type="checkbox"/> Perform Auto Program to add channels that are not presently in the memory (page 19).
Cable stations don't seem to work	<ul style="list-style-type: none"><input type="checkbox"/> Make sure Cable is set to On in the Channel menu (page 27).<input type="checkbox"/> Perform Auto Program to add channels that are not presently in the memory (page 19).

Contacting Sony

Before calling our Customer Information Services Center, reset the TV to factory settings (see page 21). Please have your TV serial number ready. The number is located on the rear of your TV and on the front cover of this manual.

Our Customer Information Services Center phone number is 1-800-222-SONY (7669) (US residents only) or (416) 499-SONY (7669) (Canadian residents only).

Specifications

Television system	American TV standard/NTSC		
Channel coverage	VHF: 2-13/UHF: 14-69/CATV: 1-125		
Antenna	75-ohm external antenna terminal for VHF/UHF		
Picture tube	FD Trinitron® tube		
Power requirements	120V, 60 Hz		
Supplied accessories	Size AA (R6) batteries (2) Remote Control RM-Y180 (1)		
Inputs/outputs	Inputs	1 video, 1 audio (front) 2 video, 2 audio (rear) 1 S VIDEO 1 RF 1 Y, PB, PR, 1 audio	Outputs 1 AUDIO OUT
Optional accessories	TV Stand: SU-27F1 for KV-27FS100L		
KV-27FS100L			
Screen size	Visible screen size: 679 mm (27 inches) measured diagonally Actual screen size: 736.6 mm (29 inches) measured diagonally		
Speaker output	10 W x 2		
Power consumption	180 W in use 1 W in standby		
Dimensions (W/H/D)	770 x 590 x 490 mm (30 ¹ / ₄ x 23 ¹ / ₄ x 19 ¹ / ₄ inches)		
Mass	45.5 kg (100 lbs. 5 oz)		

Design and specifications are subject to change without notice.

Index

16:9 Enhanced **36**

A

Auto Program **19, 28**

Auto SAP **25**

B

Balance **25**

Bass **25**

Batteries

Inserting in remote **2**

Replacing **2**

C

Cable **27**

Cable Box

Connections **13**

Operating **8**

Caption Vision **36**

Channel Fix **27**

Channel Label **28**

Channel Skip/Add **28**

Color **24**

Color Temperature **24**

Connections

Cable and antenna **11**

Connecting a Camcorder **17**

Connecting a DVD Player **16**

Connecting an Audio System **17**

TV and Cable Box **13**

TV and Satellite Receiver **14**

TV and VCR **12**

TV, Satellite Receiver and VCR **15**

Current Time **35**

D

Demo **36**

DISPLAY **4**

E

Effect

Off **25**

Surround **25**

F

Favorite Channels **27**

Front Panel **2**

L

Language **36**

M

Menus

Audio **25**

Channel **27**

Parent **29**

Setup **36**

Timer **35**

Video **24**

Mode

Movie **24**

Sports **24**

Standard **24**

Vivid **24**

MTS

Auto SAP **25**

Mono **25**

Stereo **25**

P

Parental Control **30**

Picture Controls **24**

R

Ratings

English Rating **34**

French Rating **34**

Movie Rating **32**

TV Rating **32**

U.S.A. Rating **34**

Unrated **33**

Rear Panel **9**

Remote Control

Description **3**

Programming **5**

Reset **19, 37**

S

Setting the Rating **30**

Sharpness **24**

SLEEP **3**

Speaker **26**

Specifications **41**

T

Tilt Correction **36**

Timer 1 and Timer 2 **35**

Treble **25**

Troubleshooting **37**

TV Features **1**

V

Video Label **36**

VM **24**

